

CE
ISO9001:2008

JAC Series 1010~5010

Air Filter Combination (FR.L. Combination)

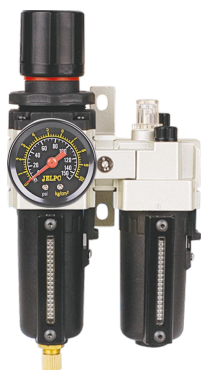

JAC3010-N



JAC2010





JAC4010

FRL

- JC
- FE
- GC
- ZYR10
- MAR300LK
- AC, BC
- AFC, BFC
- AF, BF
- AR, BR
- AFR, BFR
- AL, BL
- JAC
- JAF
- JAR
- JAW
- JAL
- PTH
- JAD

Ordering Code

JA	C	4010	04	D	N
Series	Function	Specification	Port size	Drain Type	Wiring Form
JAC2010-02 	FR.L. Combination	1010	M5: M5 x 0.8	Blank: Semi-automatic	Blank: Standard N: Metal cup
JAC3010-03 		2010	01: G 1/8"	D: Lever Auto Drain	
		3010	02: G 1/4"		
JAC3010-03N 		4010	03: G 3/8"	D1 : Lever auto-drain With external thread	
		5010	04: G 1/2"	D2 : Pulse auto-drain	
			06: G 3/4"		
		10: G 1"			

Symbol

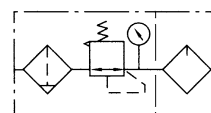

Specification

Model	JAC1010-M5	JAC2010-01	JAC2010-02	JAC3010-02	JAC3010-03	JAC4010-03	JAC4010-04	JAC4010-06	JAC5010-06	JAC5010-10	
Rated Flow	90	500	500	1700	1700	3000	3000	3000	4000	4000	
Port Size	M5	1/8	1/4	1/4	3/8	3/8	1/2	3/4	3/4	1	
Filter Precision	25 μm										
Max. Adjustable Pressure	1.0 MPa										
Proof Pressure Resistance	1.5 MPa										
Operating Temperature Range	5 ~ 60 °C										
Range of Adjustable Pressure	0.05 ~ 0.7 MPa				0.05 ~ 0.85 MPa						
Recommended Lubricant	ISO VG 32										
Container Material	Poly Carbonate										
Protective Cup Cover	Unavailable					Iron					
Drain Function	Differential Drain	Semi-automatic Drain, Automatic Drain									
Valve Type	With Overflow										
Assembly	Filter Regulator	JAW1000-M5	JAW2000-01	JAW2000-02	JAW3000-02	JAW3000-03	JAW4000-03	JAW4000-04	JAW4000-06	JAW5000-06	JAW5000-10
	Lubricator	JAL1000-M5	JAL2000-01	JAL2000-02	JAL3000-02	JAL3000-03	JAL4000-03	JAL4000-04	JAL4000-06	JAL5000-06	JAL5000-10

CE
ISO9001:2008

JAC Series

Air Filter Combination (F.R.L. Combination / FR.L. Combination)

JAC Series 1000~5000

Air Filter Combination (F.R.L. Combination)

Overall Dimension

JAC1000 ~ JAC5000

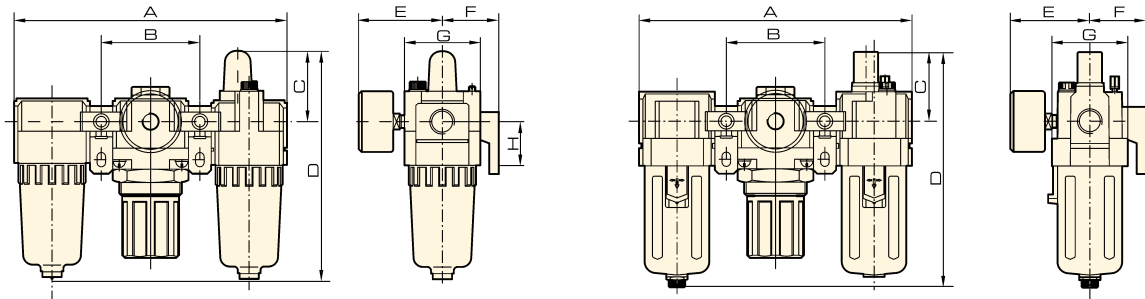

Dimension

Model	Bore	A	B	C	D	E	F	G	H
JAC1000	M5	91	33	25.5	84.5	26	25	25	20
JAC2000	1/8 - 1/4	140	50	38	125	56.8	30	40	24
JAC2500	1/4 - 3/8	181	64	38	156.5	60.8	41	53	35
JAC3000	1/4 - 3/8	181	64	38	156.5	60.8	41	53	35
JAC4000	3/8 - 1/2	238	84	41	191.5	65.5	50	70	40
JAC4000-06	3/4	253	89	41	193	69.5	50	70	40
JAC5000	3/4 - 1	300	105	48	271.5	75.5	69.8	90	50

JAC Series 1010~5010

Air Filter Combination (FR.L. Combination)

Overall Dimension

JAC1010 ~ JAC5010

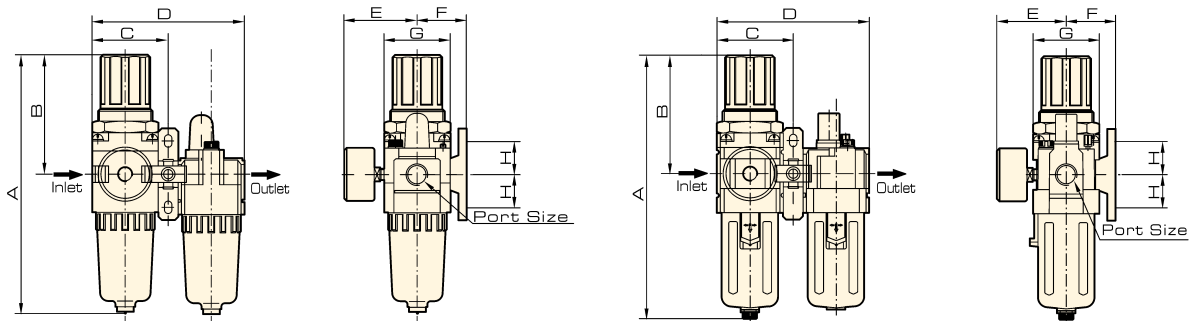

Dimension

Model	Bore	A	B	C	D	E	F	G	H
JAC1010	M5	109.5	50.5	29	58	26	25	25	20
JAC2010	1/8 - 1/4	164.5	78	45	90	56.8	30	40	24
JAC3010	1/4 - 3/8	211	92.5	58.5	117	60.8	41	53	35
JAC4010	3/8 - 1/2	262	112	77	154	70.5	50	70	40
JAC4010-06	3/4	267	114	82	164	70.5	50	70	40
JAC5010	3/4 - 1	338	116	97.5	195	75.5	69.8	90	50

FRL
AC, BC
AFC, BFC
AF, BF
AR, BR
AFR, BFR
AL, BL
JAC
JAF
JAR
JAW
JAL
JC
FE
GC
ZYR10
MAR300LK
PTH
JAD