

# Solenoid valve(3/2 way)



## 3V1 Series



3V1

### Symbol



### Product feature

1. Direct acting type and normally closed mode, flexible in direction change.
2. No need to add oil for lubrication.
3. Several valves can be installed integrately to save installation space.
4. Affiliated manual devices are equipped to facilitate installation and debugging.
5. Several standard voltage grades are optional.

### Flow chart

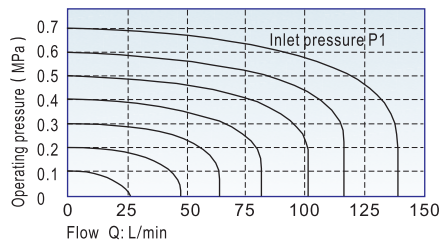

### Ordering code

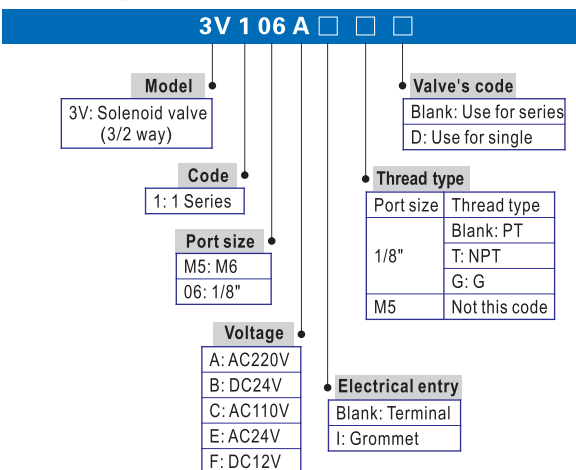

### Specification

Model	3V1-M5	3V1-06
Fluid	Air(to be filtered by 40 μm filter element)	
Acting	Direct acting	
Port size ①	M5	1/8"
Valve type	3 port 2 position	
Lubrication	Not required	
Operating pressure	0~0.8MPa(0~114psi)	
Proof pressure	1.5MPa(215psi)	
Temperature °C	-20~70	
Orifice size	Φ1.2mm	
Material of body	Aluminum alloy	

① PT thread, NPT thread and G thread are available.

### Coil specification

Item	Specification
Standard voltage	AC220V, AC110V, AC24V, DC24V, DC12V
Scope of voltage	AC: ±15% DC: ±10%
Power consumption	AC:3.5VA DC:3.0W
Protection	IP65(DIN40050)
Temperature classification	B Class
Electrical entry	Terminal, Grommet
Activating time	0.05 sec and below
Max. frequency ①	10 cycle/sec

① The maximum actuation frequency is in the no-load state.

### Inner structure

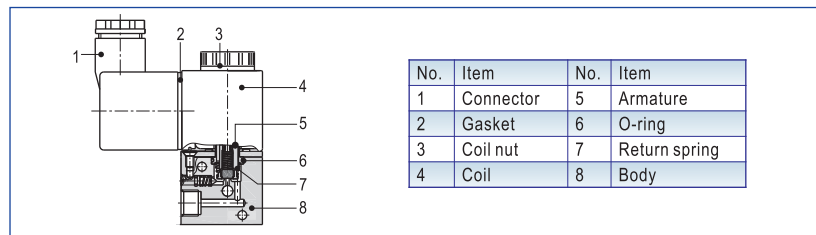

### Dimensions

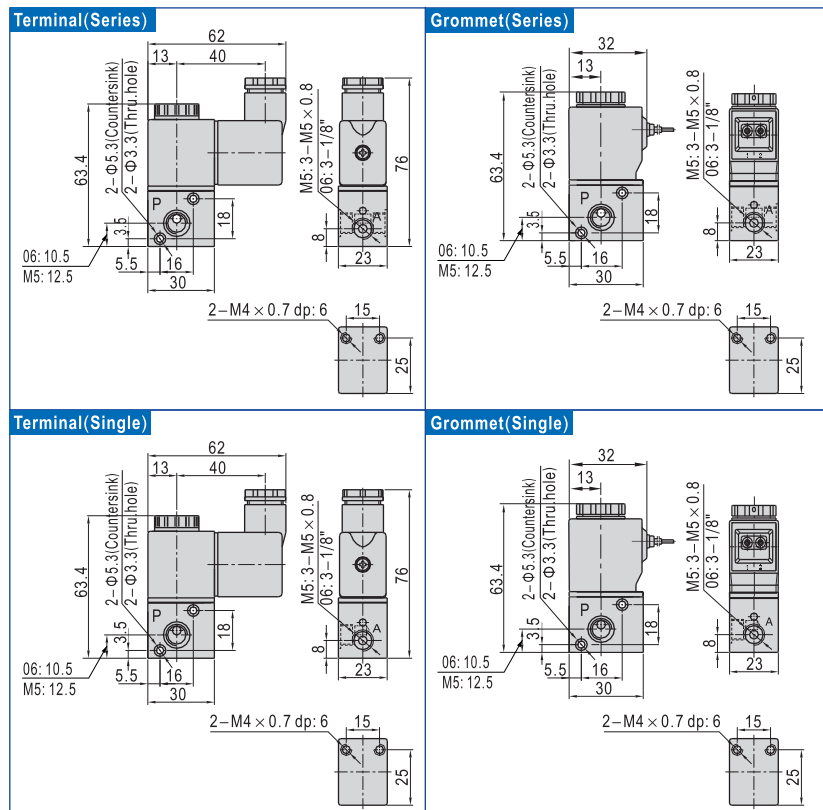

# Solenoid valve(3/2 way)



## 3V1 Series

### Series connection

#### Dimensions(3F)

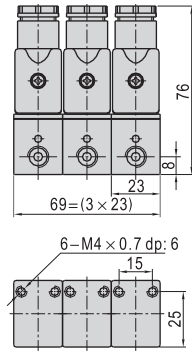

#### Dimensions(1F)

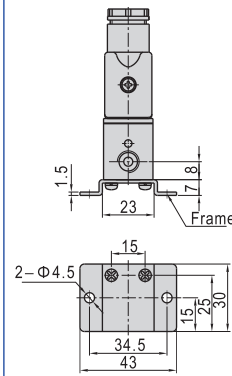

#### How to joint

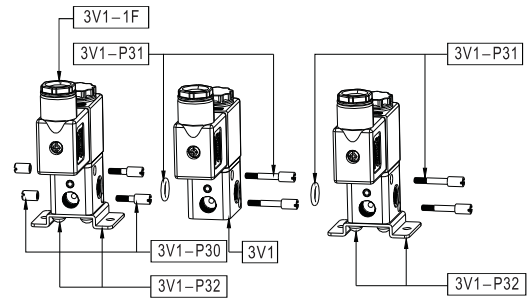

3V1

#### Product structure

Connection Amount\Q.TY	3V1	3V1-P30	3V1-P31	3V1-P32
3V1-□-□-1F	1	0	0	1
3V1-□-□-2F	2	1	1	1
.....	.....	1	.....	.....
3V1-□-□- <i>n</i> F	<i>n</i>	1	<i>n</i> -1	2

Note: *n* is the number of junction valve, and  $n \geq 3$

### Ordering code for series

**3V1 06 A □ 3F □**

- Model**
  - 3V: Solenoid valve(3/2 way)
- Port size**
  - M5: M6
  - 06: 1/8"
- Voltage**
  - A: AC220V
  - B: DC24V
  - C: AC110V
  - E: AC24V
  - F: DC12V
- Electrical entry**
  - Blank: Terminal
  - I: Grommet
- Thread type**

Port size	Thread type
1/8"	Blank: PT
	T: NPT
	G: G
M5	Not this code
- Number of stations**

1F: 1 Station
2F: 2 Station
3F: 3 Station
.....
20F: 20 Station

The above codes have included the series accessories, so it is unnecessary to order the accessories specially. But if you like, you could order as follows.

Code of accessories	Accessory name	Part code	Part name	Quantity
3V1-P30	Coupling screw assembly	F-3V1002B	Coupling screw(S)	2
		F-3V1003B	Coupling screw(M)	2
3V1-P31	Coupling screw assembly	GOR20008N75	O-Ring	1
		F-3V1004B	Coupling screw(L)	2
3V1-P32	Bracket assembly	F-3V1001B	Fixed mounting	1
		GSDA04008ZA	Cross round head screw	2

