







Mini cylinder(Stainless steel)——MA Series

Product series

Series name	Mounting type				Acting type	Bore size	Collocation of sensor switch					
	Basic	LB	FA	SDB			CS1-M	DS1-M	CS1-F	DS1-F	CS1-U	DS1-U
Double acting type: MA Double acting with adj. cushion:MAC 	●	●	●	●	Double acting Double acting (with adj. cushion)	16	●	●				
Single acting type: MSA, MTA 	●	●	●	●	Single acting	20	●	●				
Double rod type: MAD, MACD 	●	●	●		Double acting Double acting (with adj. cushion)	25	●	●				
Adjustable stroke type: MAJ, MACJ 	●	●	●			32	●	●				
Other series: MAR 					40	●	●					
					Double acting Double acting (with adj. cushion)	50	●	●	●	●	●	●
						63	●	●	●	●	●	●
					Double acting Double acting (with adj. cushion)	20	●	●				
						25	●	●				
					32	●	●					
					40	●	●					
					50	●	●	●	●	●	●	
					63	●	●	●	●	●	●	
Page	240	245				419						

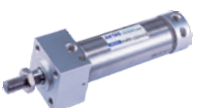

MA

Installation and application

- When load changes in the work, the cylinder with abundant output capacity shall be selected.
- Relative cylinder with high temperature resistance or corrosion resistance shall be chosen under the condition of high temperature or corrosion.
- Necessary protection measure shall be taken in the environment with higher humidity, much dust or water drops, oil dust and welding dregs.
- Dirty substances in the pipe must be eliminated before cylinder is connected with pipeline to prevent the entrance of particles into the cylinder.
- The medium used by cylinder shall be filtered to 40 μ m or below.
- Anti-freezing measure shall be adopted under low temperature environment to prevent moisture freezing.
- The cylinder shall be carried out test run without load before application. Prior to run, buffer shall be turned to the minimum and gradually released to avoid the damage on cylinder caused by excessive impact.
- To avoid side load, otherwise, piston rod will be bent and deformed and damage the thread at the end of the rod. Single-acting type can not be added in return.
- If the cylinder is dismantled and stored for a long time, please to conduct anti-rust treatment to the surface. Anti-dust caps shall be added in air inlet and outlet ports. The front and back cover can not be dismantled, which shall be especially noticed.

Criteria for selection: Cylinder thrust

Unit: Newton(N)

Bore size (mm)	Rod size (mm)	Acting type	Pressure area (mm ²)	Operating pressure(MPa)							
				0.1	0.2	0.3	0.4	0.5	0.6	0.7	
16	6	Single acting	Push side	201.0	-	-	20.1	40.2	60.3	80.4	100.5
			Pull side	172.7	-	-	11.6	28.9	46.2	63.4	80.7
		Double acting	Push side	201.0	20.1	40.2	60.3	80.4	100.5	120.6	140.7
			Pull side	172.7	17.3	34.5	51.8	69.1	86.4	103.6	120.9
20	8	Single acting	Push side	314.0	-	15.7	47.1	78.5	109.9	141.3	172.7
			Pull side	263.8	-	5.7	32.0	58.4	84.8	111.2	137.5
		Double acting	Push side	314.0	31.4	62.8	94.2	125.6	157.0	188.4	219.8
			Pull side	263.8	26.4	52.8	79.1	105.5	131.9	158.3	184.7
25	10	Single acting	Push side	490.6	-	24.6	73.7	122.8	171.8	220.9	269.9
			Pull side	412.1	-	8.9	50.1	91.4	132.6	173.8	215.0
		Double acting	Push side	490.6	49.1	98.1	147.2	196.2	245.3	294.4	343.4
			Pull side	412.1	41.2	82.4	123.6	164.8	206.1	247.3	288.5
32	12	Single acting	Push side	804.3	-	40.2	120.6	200.9	281.3	361.7	442.1
			Pull side	691.2	-	17.6	86.6	155.7	224.8	293.9	363.0
		Double acting	Push side	804.3	80.4	160.9	241.3	321.7	402.2	482.6	563.0
			Pull side	691.2	69.1	138.2	207.4	276.5	345.6	414.7	483.8
40	16	Single acting	Push side	1256.6	-	62.8	188.4	314.0	439.6	565.2	690.8
			Pull side	1055.6	-	22.6	128.1	233.6	339.1	444.6	550.1
		Double acting	Push side	1256.6	125.7	251.3	377.0	502.6	628.3	754.0	879.6
			Pull side	1055.6	105.6	211.1	316.7	422.2	527.8	633.4	738.9
50	16	Double acting	Push side	1962.5	196.3	392.5	588.8	785.0	981.3	1177.5	1373.8
		Pull side	1761.5	176.2	352.3	528.5	704.6	880.8	1056.9	1233.1	
63	16	Double acting	Push side	3115.7	311.6	623.1	934.7	1246.3	1557.9	1869.4	2181.0
		Pull side	2914.7	291.5	582.9	874.4	1165.9	1457.4	1748.8	2040.3	



Mini cylinder(Stainless steel)



MA Series



Symbol

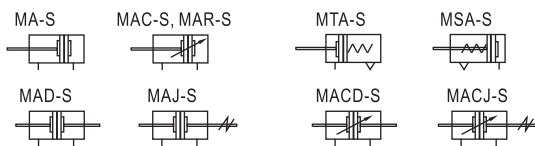

Product feature

- Standard cylinder manufactured by our enterprise.
- Piston adopts heterogeneous two-way seal structure. It has compact size and has the function of grease reservation.
- Front cover has fixed bumper which can reduce the impact of direction change of the cylinder.
- There are several modes of back cover, which makes the installation of cylinder more convenient.
- Front and back cover and stainless steel block adopt riveted rolling packed structure to form a reliable connection.
- The cylinder body has stainless steel pipes with high precision to produce high strength and corrosion resistance.
- There are cylinders and mounting accessories with several specifications for your choice.
- All cylinders of this series have magnet.

Specification

Bore size(mm)	16	20	25	32	40	50	63	
Acting type	MSA, MTA		Single acting				-	
	MA, MAD, MAJ		Double acting				-	
	MAR		-		Double acting			
	MAC, MACD, MACJ		-		Double acting with cushion			
Fluid	Air(to be filtered by 40 μ m filter element)							
Operating pressure	Double acting		0.1~1.0MPa(15~145psi)(1.0~10.0bar)					-
	Single acting		0.2~1.0MPa(28~145psi)(2.0~10.0bar)					-
Proof pressure	1.5MPa(215psi)(15bar)							
Temperature °C	-20~70							
Speed range mm/s	Double acting: 30~800		Single acting: 50~800					
Stroke tolerance	0~150 ^{+1.0} ₀ >150 ^{+1.4} ₀							
Cushion type	MAC、MACD、MACJ Series: Adjustable cushion				Other series: Bumper			
Port size (1)	M5 × 0.8		1/8"			1/4"		

(1) PT thread, NPT thread and G thread are available. Add) Refer to P419~442 for detail of sensor switch.

Stroke

Bore size (mm)	Standard stroke (mm)																Max. std stroke	Max. stroke	
	16	20	25	32	40	50	63	75	80	100	125	150	160	175	200	250			300
MA MAC	16	25	50	75	80	100	125	150	160	175	200	250	300	350	400	450	500	200	500
	20	25	50	75	80	100	125	150	160	175	200	250	300	350	400	450	500	300	600
MAR	20	25	50	75	80	100	125	150	160	175	200	250	300	350	400	450	500	300	600
	25,32,40,50,63	25	50	75	80	100	125	150	160	175	200	250	300	350	400	450	500	500	700
MSA	16	25	50	75	100	125	150	-	-	-	-	-	-	-	-	-	-	-	-
	20,25,32,40	25	50	75	100	125	150	-	-	-	-	-	-	-	-	-	-	-	-
MTA	16,20,25,32,40	25	50	75	100	125	150	-	-	-	-	-	-	-	-	-	-	-	-
MAD	16	25	50	75	80	100	125	150	160	-	-	-	-	-	-	-	-	-	-
MACD	20	25	50	75	80	100	125	150	160	175	200	-	-	-	-	-	-	-	-
MAJ	25,32,40,50,63	25	50	75	80	100	125	150	160	175	200	250	-	-	-	-	-	-	-
MACJ	25,32,40,50,63	25	50	75	80	100	125	150	160	175	200	250	-	-	-	-	-	-	-

Note) Consult us for non-standard stroke.

Ordering code

MA	20 × 50	S	CM	<input type="checkbox"/>	<input type="checkbox"/>
MAD	20 × 50	S		<input type="checkbox"/>	<input type="checkbox"/>
MAJ	20 × 50-20	S		<input type="checkbox"/>	<input type="checkbox"/>
MAR	U 20 × 50	S		<input type="checkbox"/>	

Model		Thread type (2)	
MA: Mini cylinder(Double acting)		Blank: PT	
MSA: Mini cylinder(Single acting_push)		T: NPT	
MTA: Mini cylinder(Single acting_pull)		G: G	
MAD: Mini cylinder(Double rod)			
MAJ: Mini cylinder(Adjustable stroke)			
MAR: Mini cylinder(Double acting with cushion)			
MAC: Mini cylinder(Double acting with cushion)			
MACD: Mini cylinder(Double rod with cushion)			
MACJ: Mini cylinder(Adjustable stroke with cushion)			

Mounting type (1)	
Model	Mounting type
MA	Blank: No accessories
MAC	FA: FA type
MSA	SDB: SDB type
MTA	LB: LB type
MAD	Blank: No accessories
MACD	FA: FA type
MAJ	LB: LB type
MACJ	LB: LB type
MAR	No this code

Back cover	
Model	Back cover
MA,MAC	CA: Pivot type
MSA	U: Flat-end type
MTA	CM: Round-end type
Others	No this code

Magnet	
S:	With magnet

Adjustable stroke	
Model	Adjustable stroke
MAJ MACJ	10: 10mm
	20: 20mm
	30: 30mm
	40: 40mm
	50: 50mm
	75: 75mm
100: 100mm	
Others	No this code

Front cover	
Model	Front cover
MAR	F: Front mounting type
	U: Up mounting type
Others	No this code

Bore size	
Model	Bore size
MA, MSA, MTA, MAD, MAJ	16 20 25 32 40
MAC, MAR, MACD, MACJ	20 25 32 40 50 63

Stroke	
Refer to stroke table for details	

(1) Please refer to page 245 for accessory parts.

(2) Standard thread is blank here.



Mini cylinder(Stainless steel)

MA Series

Inner structure and material of major parts

MA-CA

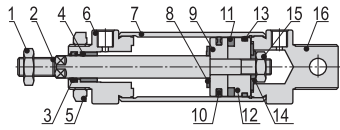

NO.	Item	Material
1	Rod nut	Carbon steel
2	Piston rod	Carbon steel with 20 μ m chrome plated
3	Front cover packing	NBR
4	Bushing	Wear resistant material
5	Front cover nut	Carbon steel
6	Front cover	Aluminum alloy
7	Barrel	Stainless steel
8	Bumper	NBR
9	Piston	Aluminum alloy
10	Piston seal	NBR
11	Magnet	Plastic
12	Magnet holder	Aluminum alloy
13	Wear ring	Wear resistant material
14	Washer	Free cutting material
15	Nut	Carbon steel
16	Back cover	Aluminum alloy

Dimensions

MA Φ16~Φ40
MAC Φ20~Φ40

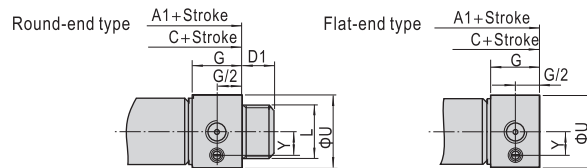
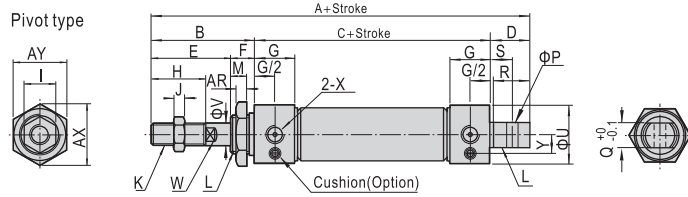

Bore size\Item	A	A1	B	C	D	D1	E	F	G	H	I	J	K
16	114	98	38	60	16	16	22	16	10	16	10	5	M6 × 1.0
20	137	116	40	76	21	12	28	12	16	20	12	6	M8 × 1.25
25	141	120	44	76	21	14	30	14	16	22	17	6	M10 × 1.25
32	147	120	44	76	27	14	30	14	16	22	17	6	M10 × 1.25
40	149	122	46	76	27	14	32	14	16.7	24	17	7	M12 × 1.25

Bore size\Item	L	M	P	Q	R	S	U	V	W	X	AR	AX	AY	Y
16	M16 × 1.5	14	6	12	14	9	21	6	5	M5 × 0.8	6	25	22	-
20	M22 × 1.5	10	8	16	19	12	27	8	6	1/8"	7	33	29	8.7
25	M22 × 1.5	12	8	16	19	12	30	10	8	1/8"	7	33	29	10.2
32	M24 × 2.0	12	10	16	25	15	35	12	10	1/8"	8	37	32	12
40	M30 × 2.0	12	12	20	25	15	41.6	16	14	1/8"	9	47	41	15

MAC Φ50, Φ63

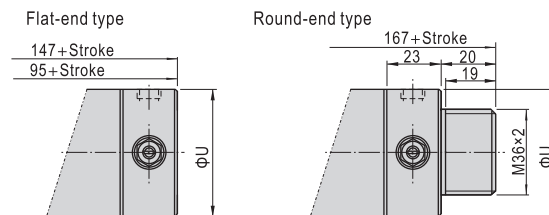
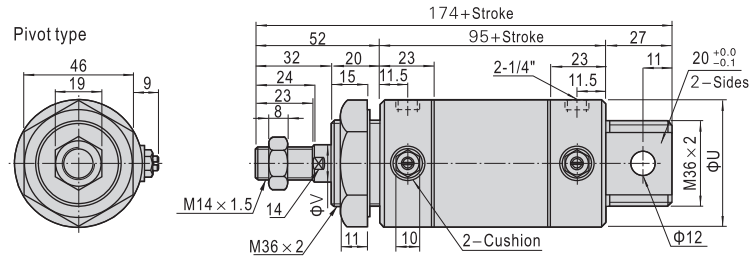

Bore size\Item	U	V
50	53	16
63	67	16



MA

Mini cylinder(Stainless steel)

MA Series

MSA $\Phi 16 \sim \Phi 40$

Item	A				A1				B				C				D	D1	E	F	G	H
	≤ 50	51~100	≥ 101	-	≤ 50	51~100	≥ 101	-	≤ 50	51~100	≥ 101	-	≤ 50	51~100	≥ 101							
16	139	164	-	123	148	-	38	85	110	-	16	16	22	16	10	16						
20	162	187	212	141	166	191	40	101	126	151	21	12	28	12	16	20						
25	166	191	216	145	170	195	44	101	126	151	21	14	30	14	16	22						
32	172	197	222	145	170	195	44	101	126	151	27	14	30	14	16	22						
40	174	199	224	147	172	197	46	101	126	151	27	14	32	14	16.7	24						

Bore size\Item	J	K	L	M	P	Q	R	S	U	V	W	X	AR	AX	AY	
16	10	5	M6 × 1.0	M16 × 1.5	14	6	12	14	9	21	6	5	M5 × 0.8	6	25	22
20	12	6	M8 × 1.25	M22 × 1.5	10	8	16	19	12	27	8	6	1/8"	7	33	29
25	17	6	M10 × 1.25	M22 × 1.5	12	8	16	19	12	30	10	8	1/8"	7	33	29
32	17	6	M10 × 1.25	M24 × 2.0	12	10	16	25	15	35	12	10	1/8"	8	37	32
40	17	7	M12 × 1.25	M30 × 2.0	12	12	20	25	15	41.6	16	14	1/8"	9	47	41



MTA $\Phi 16 \sim \Phi 40$

Item	A				A1				B	C				D	D1	E	F
	≤ 25	≤ 50	≤ 75	≤ 100	≤ 25	≤ 50	≤ 75	≤ 100		≤ 25	≤ 50	≤ 75	≤ 100				
16	129	139	154	164	113	123	138	148	38	75	85	100	110	16	16	22	16
20	152	162	177	187	131	141	156	166	40	91	101	116	126	21	12	28	12
25	156	166	181	191	135	145	160	170	44	91	101	116	126	21	14	30	14
32	162	172	192	192	135	145	165	165	44	91	101	121	121	27	14	30	14
40	164	174	194	204	137	147	167	177	46	91	101	121	131	27	14	32	14

Bore size\Item	G	H	I	J	K	L	M	P	Q	R	S	U	V	W	X	AR	AX	AY
16	10	16	10	5	M6 × 1.0	M16 × 1.5	14	6	12	14	9	21	6	5	M5 × 0.8	6	25	22
20	16	20	12	6	M8 × 1.25	M22 × 1.5	10	8	16	19	12	27	8	6	1/8"	7	33	29
25	16	22	17	6	M10 × 1.25	M22 × 1.5	12	8	16	19	12	30	10	8	1/8"	7	33	29
32	16	22	17	6	M10 × 1.25	M24 × 2.0	12	10	16	25	15	35	12	10	1/8"	8	37	32
40	16.7	24	17	7	M12 × 1.25	M30 × 2.0	12	12	20	25	15	41.6	16	14	1/8"	9	47	41



Mini cylinder(Stainless steel)



MA Series

MAD, MACD

Φ 16~Φ 40

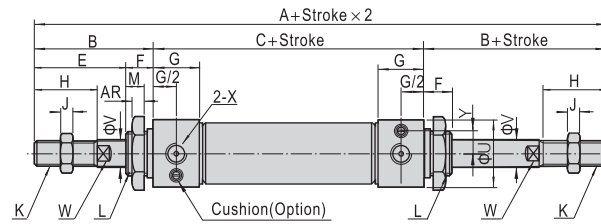
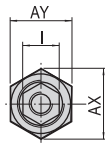

Φ 50, Φ 63

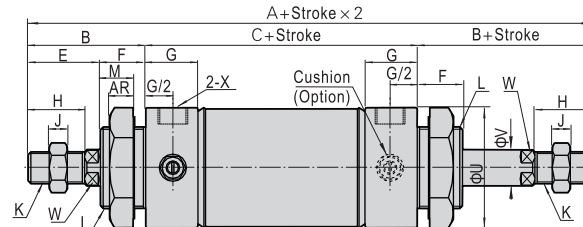
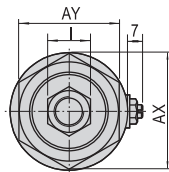

Bore size\Item	A	B	C	E	F	G	H	I	J	K	L	M	U	V	W	X	AR	AX	AY	Y
16	136	38	60	22	16	10	16	10	5	M6 × 1.0	M16 × 1.5	14	21	6	5	M5 × 0.8	6	25	22	-
20	156	40	76	28	12	16	20	12	6	M8 × 1.25	M22 × 1.5	10	27	8	6	1/8"	7	33	29	8.7
25	164	44	76	30	14	16	22	17	6	M10 × 1.25	M22 × 1.5	12	30	10	8	1/8"	7	33	29	10.2
32	164	44	76	30	14	16	22	17	6	M10 × 1.25	M24 × 2.0	12	35	12	10	1/8"	8	37	32	12
40	168	46	76	32	14	16.7	24	17	7	M12 × 1.25	M30 × 2.0	12	41.6	16	14	1/8"	9	47	41	15
50	199	52	95	32	20	23	24	19	8	M14 × 1.5	M36 × 2.0	15	53	16	14	1/4"	11	53	46	-
63	199	52	95	32	20	23	24	19	8	M14 × 1.5	M36 × 2.0	15	67	16	14	1/4"	11	53	46	-

MAJ, MACJ

Φ 16~Φ 40

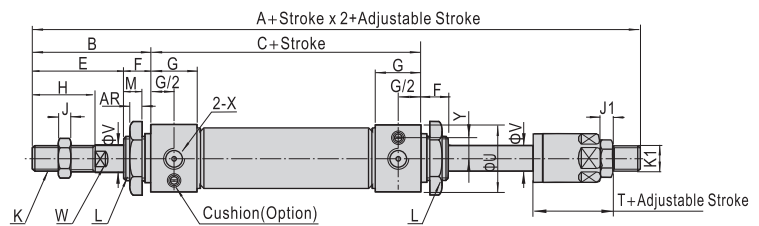
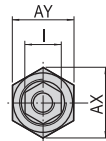

Φ 50, Φ 63

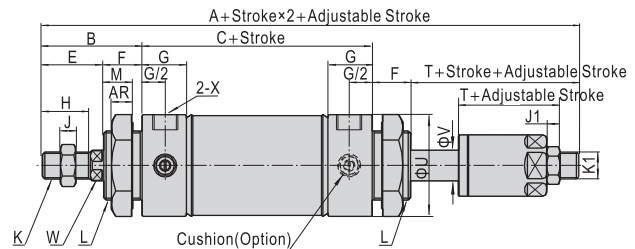
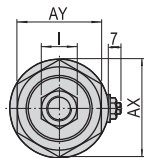

Bore size\Item	A	B	C	E	F	G	H	I	J	J1	K	K1
16	135	38	60	22	16	10	16	10	5	5	M6 × 1.0	M6 × 1.0
20	153	40	76	28	12	16	20	12	6	6	M8 × 1.25	M8 × 1.25
25	161	44	76	30	14	16	22	17	6	6	M10 × 1.25	M10 × 1.25
32	161	44	76	30	14	16	22	17	6	6	M10 × 1.25	M10 × 1.25
40	164	46	76	32	14	16.7	24	17	7	7	M12 × 1.25	M12 × 1.25
50	195	52	95	32	20	23	24	19	8	7	M14 × 1.5	M12 × 1.25
63	195	52	95	32	20	23	24	19	8	7	M14 × 1.5	M12 × 1.25

Bore size\Item	L	M	U	V	W	X	AR	AX	AY	Y	T
16	M16 × 1.5	14	21	6	5	M5 × 0.8	6	25	22	-	21
20	M22 × 1.5	10	27	8	6	1/8"	7	33	29	8.7	25
25	M22 × 1.5	12	30	10	8	1/8"	7	33	29	10.2	27
32	M24 × 2.0	12	35	12	10	1/8"	8	37	32	12	27
40	M30 × 2.0	12	41.6	16	14	1/8"	9	47	41	15	28
50	M36 × 2.0	15	53	16	14	1/4"	11	53	46	-	28
63	M36 × 2.0	15	67	16	14	1/4"	11	53	46	-	28



MA

Mini cylinder(Stainless steel)



MA Series

MARU(Up mounting type)

Φ20~Φ40

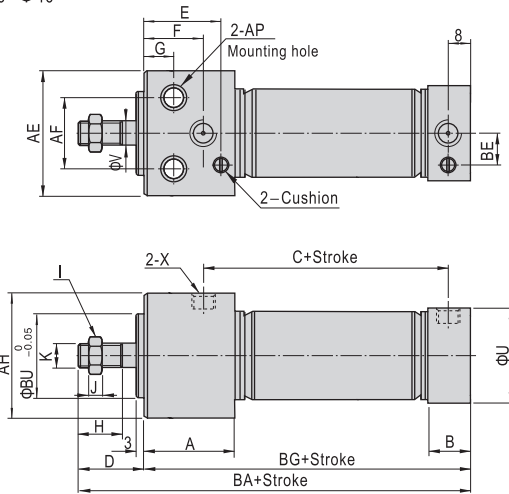

Bore size\Item	A	B	C	D	E	F	G	H	I	J	K	U	V
20	29	16	59	31	24	22	12	20	13	5	M8 × 1.25	27	8
25	29	16	59	33	24	22	12	22	17	6	M10 × 1.25	30	10
32	29	16	59	33	25	22	12	22	17	6	M10 × 1.25	35	12
40	37.5	16.6	62	35	31	27	15	24	19	8	M14 × 1.5	41.6	16

Bore size\Item	X	AE	AF	AP	AH	BA	BE	BG	BU
20	1/8"	33.5	21	Φ9.5 Dp:6.5 Thru.hole: Φ5.5	30.3	120	8.7	89	20
25	1/8"	39	25	Φ11.0 Dp:7.5 Thru.hole: Φ6.6	36.3	122	10.2	89	26
32	1/8"	47	30	Φ14.0 Dp:10 Thru.hole: Φ9.0	42.3	122	12	89	26
40	1/8"	58.5	38	Φ17.5 Dp:12.5 Thru.hole: Φ11	52.3	132.6	15	97.6	32

MARF(Front mounting type)

Φ20~Φ40

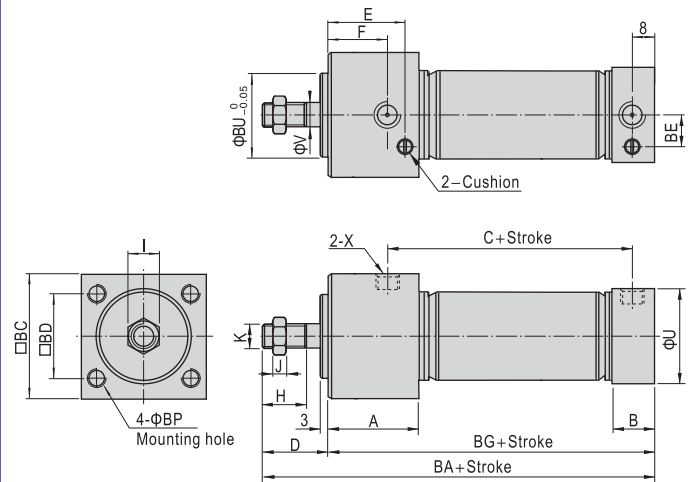

Bore size\Item	A	B	C	D	E	F	H	I	J	K	U
20	29	16	59	31	24	22	20	13	5	M8 × 1.25	27
25	29	16	59	33	24	22	22	17	6	M10 × 1.25	30
32	29	16	59	33	25	22	22	17	6	M10 × 1.25	35
40	37.5	16.6	62	35	31	27	24	19	8	M14 × 1.5	41.6

Bore size\Item	V	X	BA	BC	BD	BE	BG	BP	BU
20	8	1/8"	120	30.5	22	8.7	89	M5 × 0.8Dp:9	20
25	10	1/8"	122	36.5	26	10.2	89	M6 × 1.0Dp:11	26
32	12	1/8"	122	42.5	30	12	89	M6 × 1.0Dp:11	26
40	16	1/8"	132.6	52.5	36	15	97.6	M8 × 1.25Dp:14	32

Φ50, Φ63

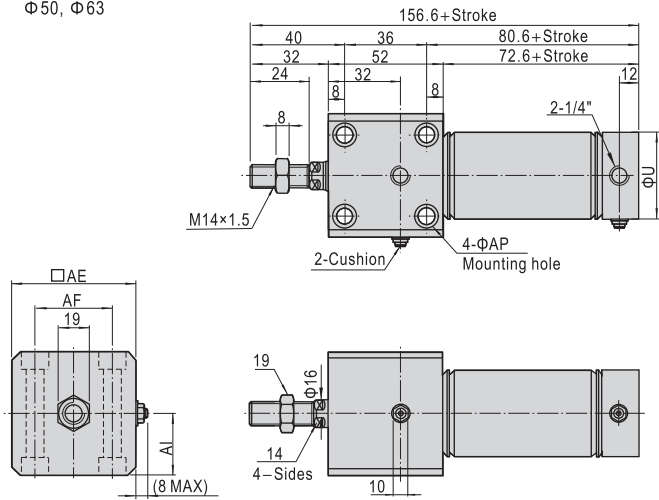

Bore size\Item	U	AE	AF	AI	AP
50	53	62	44	31	Both sides: Φ11.0 Dp:6.5 Thru.hole: Φ6.6
63	67	74	48	37	Both sides: Φ14.0 Dp:8.5 Thru.hole: Φ9.0

Φ50, Φ63

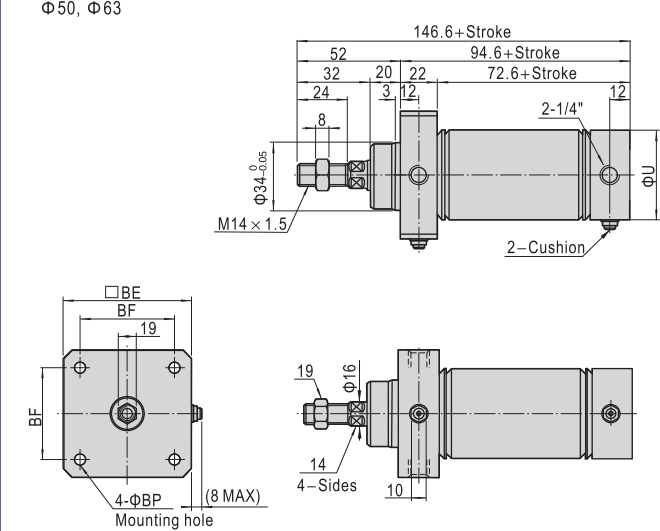

Bore size\Item	U	BE	BF	BP
50	53	62	48	6.6
63	67	74	58	9.0



Mini cylinder(Stainless steel)

Accessories

Ordering code

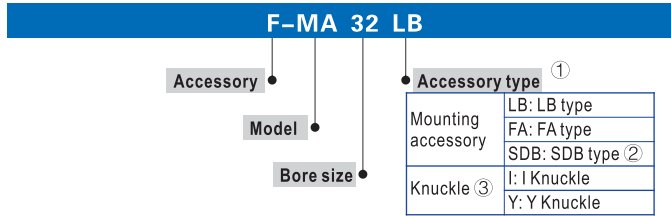

- ① Please refer to accessory list for selection and ordering information.
- ② SDB is attached with relevant PIN.
- ③ Please refer to page 417, 418 for others knuckle.

Accessory selection

Accessories\Cylinder model	MA, MAC	MSA, MTA	MAD, MACD	MAJ, MACJ	MAR
Mounting accessory	LB ●	●	●	●	×
	FA ●	●	●	●	×
	SDB ●	●	×	×	×
Knuckle ①	I ●	●	●	●	●
	Y ●	●	●	●	●
	U ●	●	●	●	●
	F ●	●	●	●	●
Sensor switch ②	CS1-M ●	●	●	●	●
	DS1-M ●	●	●	●	●
	CS1-F ●	●	●	●	●
	DS1-F ●	●	●	●	●
	CS1-U ●	●	●	●	●
	DS1-U ●	●	●	●	●

- ① Please refer to P415-418 for knuckle detail,
- ② Please refer to P419-442 for detail of sensor switch.

Material of accessories

Accessories	Mounting accessories			Knuckle			
	LB	FA	SDB	I	Y	F	U
Bore size	LB	FA	SDB	I	Y	F	U
16-63	○	○	○	□	□	□	□

○—Low carbon steel, □—Carbon steel.

List for ordering code of accessories

Accessories	Mounting accessory		
	LB	FA	SDB
Bore size	LB	FA	SDB
16	F-MA16LB	F-MA16FA	F-MA16SDB
20	F-MA20LB	F-MA20FA	F-MA20SDB
25	F-MA20LB	F-MA20FA	F-MA20SDB
32	F-MA32LB	F-MA32FA	F-MA32SDB
40	F-MA40LB	F-MA40FA	F-MA40SDB
50	-	-	F-MA40SDB
63	-	-	F-MA40SDB

Accessories	Knuckle			
	I: I Knuckle	Y: Y Knuckle	F: F Knuckle	U: U Knuckle
Bore size	I: I Knuckle	Y: Y Knuckle	F: F Knuckle	U: U Knuckle
16	F-MA16I	F-MA16Y	F-M6X100F	F-M6X100U
20	F-MA20I	F-MA20Y	F-M8X125F	F-M8X125U
25	F-MA25I	F-MA25Y	F-M10X125F	F-M10X125U
32	F-MA32I	F-MA32Y	F-M12X125F	F-M12X125U
40	F-MA40I	F-MA40Y	F-M12X125F	F-M12X125U
50	F-MA50I	F-MA50Y	F-M14X150F	F-M14X150U
63	F-MAC50I	F-MAC50Y	F-M14X150F	F-M14X150U

Accessories	Sensor switch					
	CS1-M □	DS1-M □	CS1-F	DS1-F	CS1-U	DS1-U
Bore size	CS1-M □	DS1-M □	CS1-F	DS1-F	CS1-U	DS1-U
16	CS1-M-S16	DS1-M-S16	-	-	-	-
20	CS1-M-S20	DS1-M-S20	-	-	-	-
25	CS1-M-S25	DS1-M-S25	-	-	-	-
32	CS1-M-S32	DS1-M-S32	-	-	-	-
40	CS1-M-S40	DS1-M-S40	-	-	-	-
50	CS1-M-S50	DS1-M-S50	-	-	-	-
63	CS1-M-S63	DS1-M-S63	CS1-F	DS1-F	CS1-U	DS1-U

Dimensions

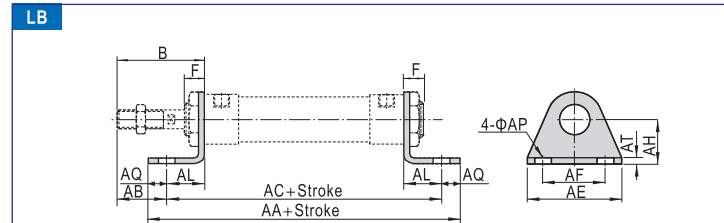

Bore size\Item	AA	AA(MSA)			AC	AC(MSA)		
		0-50	51-100	101-150		0-50	51-100	101-150
Stroke	(MA)	0-50	51-100	101-150	(MA)	0-50	51-100	101-150
16	98	123	148	-	86	111	136	-
20	122	147	172	197	106	131	156	181
25	122	147	172	197	106	131	156	181
32	142	167	192	217	126	151	176	201
40	142	167	192	217	126	151	176	201

Bore size\Item	B	F	AB	AE	AF	AL	AQ	AP	AT	AH
16	38	16	25	44	32	13	6	5.5	3	20
20	40	12	25	54	40	15	8	6.5	3	25
25	44	14	29	54	40	15	8	6.5	3	25
32	44	14	19	59	45	25	8	6.5	4	32
40	46	14	21	64	50	25	8	6.5	4	36

FA

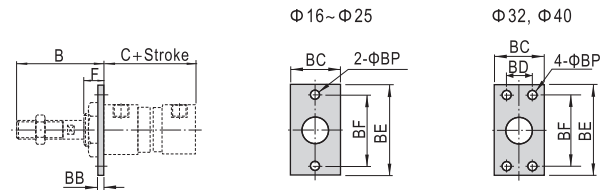

Bore size\Item	Stroke	B	C	C(MSA)			BB	BC	BD	BE	BF	BP	F
				0-50	51-100	101-150							
16	38	60	85	110	-	3	26	-	52	40	5.5	16	
20	40	76	101	126	151	4	38	-	64	50	6.5	12	
25	44	76	101	126	151	4	38	-	64	50	6.5	14	
32	44	76	101	126	151	4	47	33	72	58	6.5	14	
40	46	76	101	126	151	4	50	36	84	70	6.5	14	

SDB

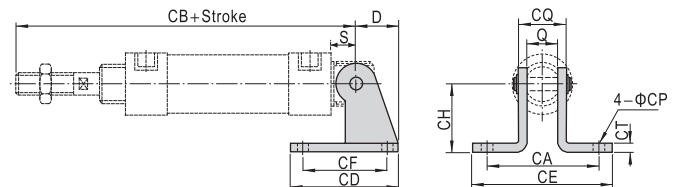

Bore size\Item	Stroke	D	S	Q	CA	CB	CB(MSA)			CD	CE	CF	CH	CT	CP	CQ
							0-50	51-100	101-150							
16	16	9	12	-	107	132	157	-	23	-	12	20	2	5.5	16	
20	21	12	16	51	128	153	178	203	48	67	32	32	3	6.5	22	
25	21	12	16	51	132	157	182	207	48	67	32	32	3	6.5	22	
32	27	15	16	51	135	160	185	210	52	67	36	36	4	6.5	24	
40	27	15	20	55	137	162	187	212	56	71	40	40	4	6.5	28	



MA

Mini cylinder(Stainless steel)

Accessories

I Knuckle

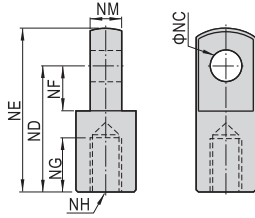

Type\Item	NC	ND	NE	NF	NG	NH	NM
F-MA16I	5	21	28	8.5	8	M6×1.0	6
F-MA20I	8	30	40	11	15	M8×1.25	8
F-MA25I	10	40	50	15	20	M10×1.25	10
F-MA40I	10	45	57	16	23	M12×1.25	14

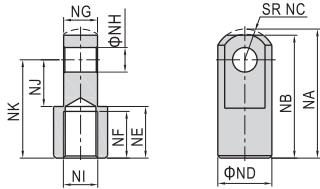

Type\Item	NA	NB	NC	ND	NE	NF	NG	NH	NJ	NK	NI
F-MAC50I	52.5	50	12.5	22	21	19	13.8	10	19	40	M14×1.5

Y Knuckle

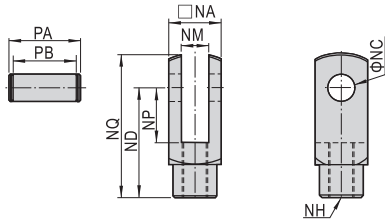

Type\Item	NA	NC	ND	NP	NQ	NM	NH	PA	PB
F-MA16Y	12	5	21	8.5	27.4	6	M6×1.0	16.8	12.4
F-MA20Y	16	8	30	15	40	8	M8×1.25	21.6	16.8
F-MA25Y	19	10	40	20	52	10	M10×1.25	25.6	19.8
F-MA40Y	25.4	10	45	20	57	14	M12×1.25	32	26.2

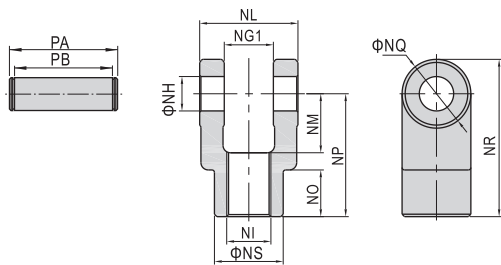

Type\Item	NG1	NH	NI	NL	NM	NO	NP	NQ	NR	NS	PA	PB
F-MAC50Y	14.2	10	M14×1.5	27.8	19	17	40	22	51	22	34.6	28.8



MA

